

Shinhoo®

Master SD

Installation and Operation Manual



CONTENTS.

| | Page. |
|----------------------------------------------------------------------|--------------|
| 1. Safety instructions | 3 |
| General information about the document | 4 |
| Meaning of symbols and description on the product | 4 |
| Qualification and training of service personnel | 4 |
| consequences of non-observance of the safety instructions | 4 |
| Performing work in compliance with safety regulations | 5 |
| Safety instructions for the user or operating personnel | 5 |
| Safety instructions for maintenance, inspections and installation | 5 |
| Independent conversion and manufacture of spare assemblies and parts | 6 |
| Unacceptable operating modes | 6 |
| 2. Transportation and storage | 6 |
| 3. Meaning of symbols and description in the document | 7 |
| 4. General product information | 7 |
| Design | 8 |
| Standard type designation | 8 |
| Nameplate | 9 |
| 5. Packing and moving | 10 |
| Packaging | 10 |
| Moving | 10 |
| 6. Scope | 10 |
| Pumped liquids | 10 |
| 7. Principle of action | 12 |
| 8. Assembly of the mechanical part | 12 |
| Pump housing location | 12 |
| Pump installation | 12 |
| Pump location requirements | 15 |
| Changing the position of the pump head | 16 |
| Installing the insulating jacket | 17 |
| 9. Connection of electrical equipment | 18 |
| Plug connection | 19 |
| PWM signal connection | 19 |
| 10. Commissioning | 20 |
| Launch | 21 |
| Venting the system | 22 |
| 11. Operation | 23 |
| Control panel | 23 |

CONTENTS.

| | Page. |
|----------------------------------------------------------|--------------|
| Pump setting | 24 |
| Control modes | 25 |
| PWM signal control | 28 |
| 12. Maintenance | 31 |
| 13. Decommissioning | 32 |
| 14. Low temperature protection | 32 |
| 15. Technical data | 33 |
| Pump operation at high and low supply voltages | 34 |
| Operating characteristics, dimensions and weight | 35 |
| 16. Troubleshooting | 41 |
| Actions in case of contamination of the pump's flow path | 43 |
| 17. Disposal of the product | 44 |
| 18. Manufacturer service | 45 |
| 19. Information on recycling packaging | 46 |

Warning



Before starting work on the installation of the equipment, it is necessary to carefully study this document. Installation and operation of the equipment must be carried out in accordance with the requirements of this document and local codes and regulations.

1. Safety instructions

Warning



This equipment must be operated by personnel with the necessary knowledge and experience.

Persons with physical, mental, visual and hearing disabilities shall not be admitted to the operation of this equipment.

Children are not allowed access to this equipment.



General information about document

The Data Sheet, Installation and Operating Instructions contain fundamental information that must be observed during installation, operation and maintenance. It is therefore essential that the relevant operating personnel or the user familiarizes themselves with them before installation and commissioning. This document must be permanently available at the place of use of the equipment.

In addition to the general safety instructions in section 1. Safety Notes, but also the special safety notes in the other sections.

Meaning of symbols and inscriptions on the product

Instructions placed directly on the equipment, e.g:

- arrow indicating the direction of rotation,
- designation of the pressure connection for pumped medium supply,

must be compulsorily observed and preserved so that they can be read at any time.

Qualification and training of service personnel

Personnel who carry out operation, maintenance and inspection work as well as installation of the equipment must have the appropriate qualifications for the job. The scope of matters for which the personnel are responsible and which they must supervise, as well as their area of competence, must be precisely defined by the user.

Dangerous consequences of non-observance of the safety instructions

Failure to observe the safety instructions may result in:

- dangerous consequences for human health and life;
- endangering the environment;
- voiding all warranty claims for damages;
- failure of critical equipment functions;



- ineffectiveness of prescribed maintenance and repair methods;
- a dangerous situation for the health and life of personnel due to electrical or mechanical factors.

Performing work in compliance with safety techniques

The safety instructions in this document, the existing national safety regulations as well as any internal work, operating and safety regulations applicable to the user must be observed during the work.

Safety instructions for the user or the personnel operating

- It is forbidden to dismantle the existing protective guards for moving parts and components when the equipment is located in operation.
- The possibility of electrical hazards must be excluded (for more details see, for example, the regulations of the PUE and the local power supply companies).

Safety instructions for maintenance, inspection and installation work

The user must ensure that all maintenance, inspection and installation work is carried out by qualified personnel who are authorized to carry out such work and have been sufficiently familiarized with it through a detailed study of the installation and operating instructions.

All work must always be carried out with the equipment switched off. The shutdown procedure described in the installation and operating instructions must be strictly adhered to.

Immediately after completion of work, all safety and protection devices that have been removed must be reinstalled or switched on again.



Self-conversion and manufacture of spare parts and components

Conversion or modification of the devices may only be carried out in agreement with the manufacturer.

Original spare parts and components as well as components authorized by the manufacturer are designed to ensure reliable operation.

The use of assemblies and parts from other manufacturers may cause the manufacturer to deny liability for any resulting consequences.

Unacceptable operating modes

The operational reliability of the supplied equipment is guaranteed only if it is used according to with functional purpose according to section 6.

Scope of

application. The maximum permissible values specified in the technical data must be compulsorily observed in all cases.

2. Transportation and storage



The equipment should be transported in covered wagons, closed cars, by air, river or sea transport.

During transportation, the packed equipment must be securely fastened to the means of transportation to prevent unintentional movement.

The maximum prescribed storage period is 2 years. No preservation is required during the entire storage period.

Storage and transportation temperature (in empty state) min. -30 ° C; max. +60 °C.



3. Meaning of symbols and description in the document



Warning

Non-observance of these instructions can have dangerous consequences for human health.

Attention

Safety instructions which, if not followed, may cause equipment failure, as well as damage to it.

Guideline

Recommendations or instructions to facilitate work and ensure safe operation.



Warning

Failure to follow these instructions can result in electric shock and have life- and health-threatening consequences.



Warning

Contact with hot fluids or equipment surfaces can cause burns and serious injury.

4. General information about product

This document applies to Master SD circulation pumps.

Master S pumps are designed to work in all types of heating systems, cooling systems and air-conditioning systems with variable or constant fluid flow rates. Master SD is equipped with 11 control modes:

3 constant pressure maintenance modes, 3 proportional pressure maintenance modes, 3 fixed speeds, AUTO automatic control mode.

Master SD pumps are equipped with a built-in frequency converter. Do not use an external voltage converter that converts or modifies the frequency or voltage of the pump supply to control pump performance. The stabilizers or UPS used must have a sinusoidal voltage output.

Attention

The scope of delivery includes: Master SD pump, plug, rubber seals, threaded pipe connections, technical documentation.

The equipment is not supplied with accessories and tools for adjustments, maintenance and intended use. Use standard tools in accordance with the safety requirements of the manufacturer.

Design

The pump is equipped with a permanent magnet motor and an integrated motor speed control system to ensure that the pump performance is matched to the actual demand of the heating system in which the pump is used.

The rotor of Master SD pumps is isolated from the stator by a hermetically sealed sleeve. This means that pump and motor form a single unit without shaft seals. The pump bearings are lubricated by the pumped liquid.

Standard type designation

| Example | MASTER SD 25 -4 180 |
|--------------------------------------------------------------|----------------------------|
| Typical range | _____ |
| Nominal suction diameter and pressure connections (DN), [mm] | _____ |
| Maximum head [m] | _____ |
| Mounting length [mm] | _____ |

Branded plate

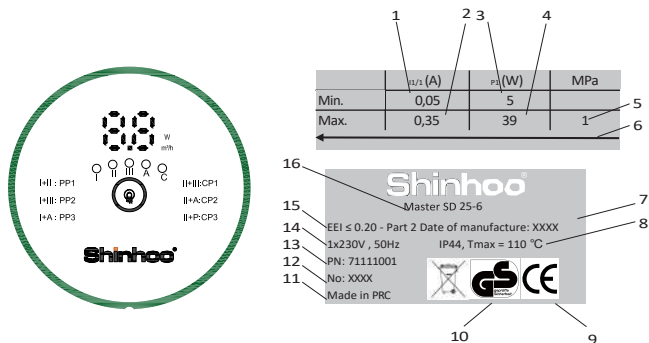

Fig. 1 Master SD pump nameplate

| Pos. | Name |
|------|------------------------------------------------------------------------------------------------|
| 1 | Minimum amperage |
| 2 | Maximum amperage |
| 3 | Minimum power consumption |
| 4 | Maximum power consumption |
| 5 | Maximum system pressure |
| 6 | Direction of rotation |
| 7 | Date of manufacture [YYWW, where YY is the year of manufacture, WW is the week of manufacture] |
| 8 | Degree of protection and maximum fluid temperature |
| 9 | Market signs |
| 10 | Manipulation sign |
| 11 | Country of manufacture |
| 12 | Serial number |
| 13 | Item |
| 14 | Pump type designation |
| 15 | Number of phases, mains voltage and rated current frequency |
| 16 | Energy Efficiency Index EEI |

5. Packing and moving

Packaging

Upon receipt of the equipment, inspect the packaging and the equipment itself for any damage that may have occurred during transportation. Before disposing of the packaging, carefully check for any documents or small parts that may have been left behind. If the equipment received does not match your order, contact to the equipment supplier.

If the equipment is damaged in transit, contact the shipping company immediately and notify the equipment supplier.

The supplier reserves the right to thoroughly inspect possible damage.

Moving



Warning

Local code restrictions for manual lifting and loading and unloading operations must be observed.

Attention

Do not lift the pump by the supply cable.

6. Area of application

Master SD pumps (hereinafter referred to as pumps) are designed for circulation of liquids in cooling and heating systems.

The motor speed can be controlled either by the built-in control modes.

Pumped fluids

In heating systems, water must meet the requirements of the heating unit mains water quality standards, e.g. VDE.

The pump is suitable for pumping the following liquids:

- Low-viscosity, clean, non-aggressive and non-explosive liquids without solid and long-fiber inclusions.

- The pH value of the pumped liquid must be between 8.2 and 9.5. The minimum value depends on the hardness of the water and must not be lower than 7.4 at 4° dH (0.712 mmol/l).
- Electrical conductivity at 25 °C should be $\geq 10 \mu\text{S/cm}$

The kinematic viscosity of water is $\nu = 1 \text{ mm}^2/\text{s}$ (1 cSt) at 20 °C. If the pump is used to pump liquids with a higher viscosity, the pump performance will be reduced.

Example: The viscosity of a pumped liquid containing 50 % glycol at 20 °C is approximately 10 mm²/sec (10 cSt), which reduces the pump capacity by about 15%.

Do not use impurities that may adversely affect the operation of the pump.

The viscosity of the pumped liquid must be taken into account when selecting the pump.



Warning

Do not use the pump for pumping flammable liquids such as diesel fuel, gasoline and other similar liquids.



Warning

Do not use the pump for pumping aggressive liquids such as acids and seawater.

Glycol

Master SD pumps can be used for pumping glycol solutions with a concentration of up to 50 %. The maximum viscosity of a 50% glycol solution at -10 °C is approximately 32 cSt.

Guideline

Pumping glycol solution changes the hydraulic characteristics of the pump. Increasing the concentration of glycol in the solution above 40% leads to a decrease in the heat capacity of the liquid and a decrease in the efficiency of the system.

To prevent the glycol solution parameters from changing, it is necessary to control the temperature of the liquid exceeding the maximum permissible value.

The operating time at high temperatures must be reduced. The system must be cleaned and flushed before adding glycol solution to the system.

The glycol solution should be checked regularly to prevent corrosion and sludge formation. If additional glycol dilution is required, follow the instructions in the glycol supplier's manual.

Attention *DEX-COOL® grade glycol can cause damage to the pump.*

7. Principle of action

The Master SD pumps work by increasing the pressure of the liquid moving from the inlet connection.

The liquid flows through the pump inlet into the rotating impeller.

The centrifugal forces increase the speed of the liquid.

The increasing kinetic energy of the fluid is converted into increased pressure at the outlet.

The rotation of the impeller is provided by an electric motor.

8. Installation of the mechanical part

Location installation

The pumps are intended for indoor installation without danger of external or atmospheric influences. The operating conditions must comply with the requirements of 15. Technical data.

The pumps must be installed in dry conditions, without danger of getting wet, e.g. from surrounding equipment.



Warning
Installation must be carried out by a specialist in accordance with local codes and regulations.

Pump housing

1. The arrows on the pump casing show the direction of liquid flow (see 2).
2. Before the pump is installed in the piping, install the two gaskets supplied with the pump (see Fig. 3).

Install the pump so that the position of the motor shaft and pump head meet the requirements in the section Pump Location Requirements.

3. Tighten the fittings (see 4).

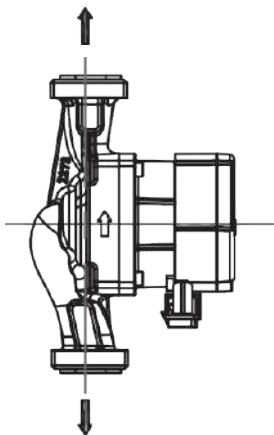

Fig. 2 Direction of flow

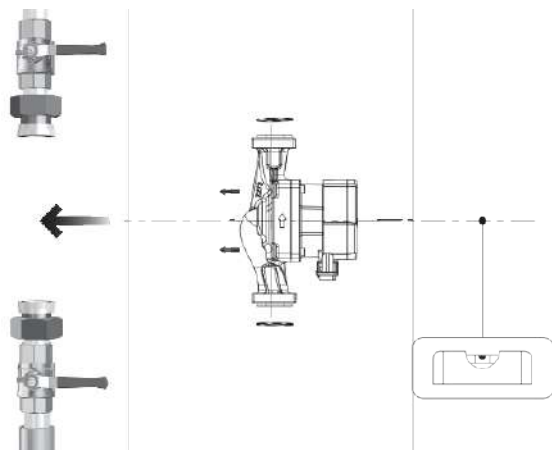

Fig. 3 Mounting the pump

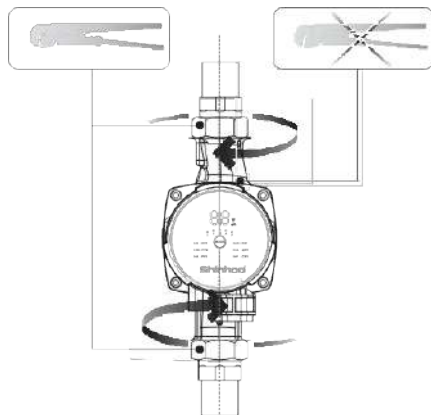

Fig. 4 Tightening the fittings

Location requirements pump

1. The pump must always be mounted so that the motor shaft is horizontal to the ground (see Fig 5).
 2. The pump head can be positioned in any of the four possible positions(see6).For information on *changing the head position*, see *Changing the Pump Head Position*.
- Examples of correct pump installation are shown in 5.

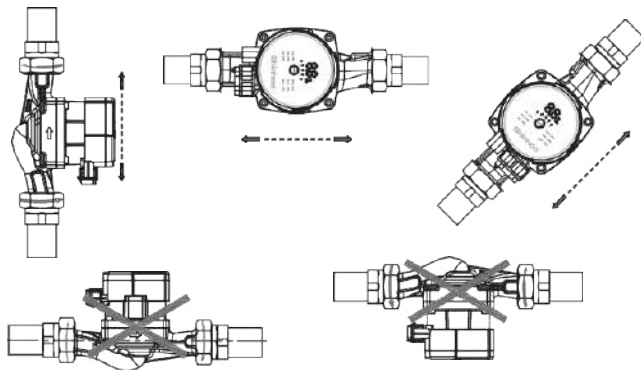

Fig. 5 Pump location

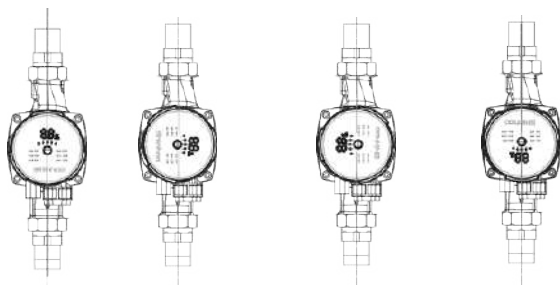

Fig. 6 Pump Head Location

Changing the position of the pump head



Warning

Turn off the power to the pump before performing any work on the pump. Once the power has been turned off, make sure that it cannot be accidentally turned back on.



Warning

The pump casing may be hot due to the high temperature of the liquid it is pumping.

Close the shut-off valves on both sides of the pump before any work is carried out and wait for the pump casing to cool down.





Warning

The pumped liquid in the system may be very hot and pressurized. Before disassembling the pump, drain the system or close the shutoff valves on both sides.

The pump head can be positioned in any of the four possible positions (see 6).

| Step | Action | Illustration |
|------|-------------------------------------------------------------------------------------------------------------|--------------|
| 1 | Make sure that the cocks on the inlet and discharge side are closed. There is no pressure inside the pump. | |
| 2 | Remove the pump head mounting screws. Hold the head piece with your hand to prevent it from falling out. | |

| Step | Action | Illustration |
|------|----------------------------------------------------------------------------------------------------|-----------------------------------------------------------------------------------|
| 3 | Turn the pump head in the shaft axis to the desired position without removing it from the cochlea. |  |
| 4 | Re-install the mounting screws and tighten crosswise. |  |
| 5 | Open the taps on the inlet and pressure side, make sure there are no leaks. |  |

Thermal losses of the pump can be reduced by installing a special thermal insulating cover on the pump casing (see 7). The thermal insulation cover is not included in the delivery of the pump.

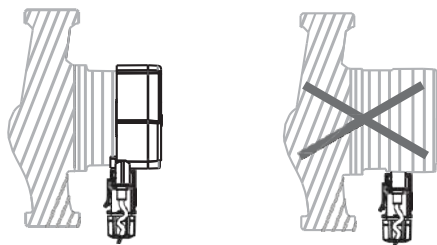

Fig. 7 Installing the insulating jacket

Attention Do not cover the control panel with insulation.

9. Connecting electrical equipment



Warning

Electrical equipment must be wired in accordance with local codes and regulations.



Warning

Turn off the power to the pump before performing any work on the pump. Once the power has been turned off, make sure that it cannot be accidentally turned back on.



Warning

The pump must be grounded. The pump must be connected to an external switch. The gap between the switch contacts on all poles must be at least 3 mm.



Warning

If the electrical insulation is damaged, the current may become a pulsating direct current. Comply with local legislation on the requirements and selection of a residual current device (RCD) when installing the pump.



Warning

Before connecting the pump, make sure that the mains power supply corresponds to the required values on the nameplate, see Nameplate section.

The motor of Master SD pumps is equipped with built-in thermal protection and does not require additional external protection.

The pump must be connected to the power supply using the special plug supplied with the pump.

Connecting plug

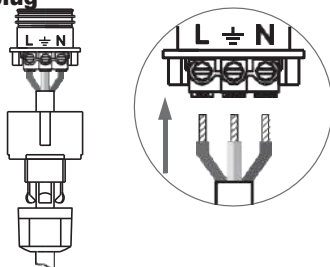

Fig. 8 Pump connection diagram

10. Commissioning

All products are subjected to acceptance testing at the factory. No additional testing is required at the installation site.

The system must be filled with operating fluid before operation.





Warning

Do not allow the pump to run without pumped liquid ("dry run")

To put the Master SD pumps into operation, the mains switch must be turned to position "On." The indicator light on the control panel will indicate that the power is on. If necessary, the pump and system must be vented before operation.

Launch

| Step | Action | Illustration |
|------|------------------------------------------------------------------------------------------|-----------------------------------------------------------------------------------|
| 1. | Open all shut-off valves |  |
| 2. | Turn on the voltage |  |
| 3. | The lights on the control panel indicate that voltage is applied and the pump is running |  |

Removing air from system

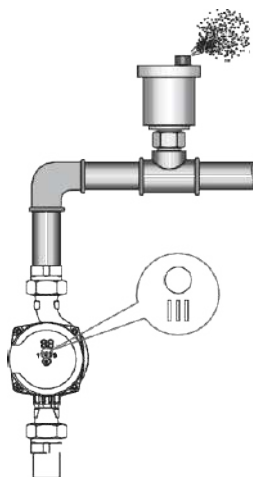

Fig. 11 Venting the system

Air is removed from the heating system by means of an automatic air release valve, installed at the top point of the system. After filling the heating system with working fluid, the following steps must be carried out:

1. Open the air release valve.
2. Use the button on the control panel to set speed III.
3. Turn on the pump for a short period of time, the exact duration of which depends on the size and design of the system.
4. After the system has been vented, i.e. after the noises have disappeared, adjust the pump as recommended, see section *Operation* for more details.

Repeat this procedure if necessary. Once the pump and the heating system have been vented, the pump can be started in operation.

11. Operation

Attention *Do not use the pump to bleed the entire system. Do not operate a pump that is not filled with operating fluid.*

The pump must not be operated for long periods of time without water in the system or without the minimum permissible inlet pressure (see section 15. *Technical data*). Failure to observe these requirements may cause damage to the motor and the pump.

Control panel

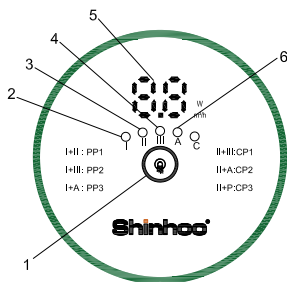

Fig. 12 Control panel

| Pos. | Description |
|------|------------------------------------------------------------|
| 1 | Button for switching pump operation modes |
| 2 | Minimum speed operation indicator (I) |
| 3 | Medium speed operation indicator (II) |
| 4 | Indicator for operation at maximum rotation speed (III) |
| 5 | Display of current power consumption and current flow rate |
| 6 | Operation indicator in AUTO mode |

Pump setting

Using the MODE button on the control panel, the pump operation modes can be switched. The constant or proportional pressure mode is selected by pressing the button. The table below shows the selection of the pump operating mode depending on the number of times the MODE button is pressed.

| Number of presses | Mode of operation | Description |
|-------------------|-------------------|-----------------------------------|
| 0 | AUTO | Automatic mode AUTO operations |
| 1 | PP1 | Proportional pressure mode |
| 2 | PP2 | |
| 3 | PP3 | |
| 4 | CP1 | Constant pressure mode |
| 5 | CP2 | |
| 6 | CP3 | |
| 7 | C1 | Fixed speed mode |
| 8 | C2 | |
| 9 | C3 | |

Switching between the display of the current energy consumption (display W) and the current flow rate (display m³/h) is done by long pressing the MODE button for 3-5 seconds.

Mode designations on the control panel

| Indicator | Mode |
|-----------|--------------------------------------|
| I | C I - minimum constant velocity |
| II | C II - average constant velocity |
| III | C III - maximum constant speed |
| A | AUTO mode |
| I+II | PP I - proportional control mode I |
| I+III | PP II - proportional control mode II |

| Indicator | Mode |
|-----------|-------------------------------------|
| I+A | PP III - proportional control III |
| II+III | CP I - constant pressure mode I |
| II+A | CP II - constant pressure mode II |
| II+C | CP III - constant pressure mode III |

Control modes

The pump has a choice of ten control modes:

- Proportional pressure mode minimum
- Proportional pressure mode medium
- Proportional pressure mode maximum
- Constant pressure mode minimum
- Constant pressure mode medium
- Constant pressure mode maximum
- Fixed speed I
- Fixed speed II
- Fixed speed III
- Automatic operation mode AUTO
- Control mode from PWM input signal.

Proportional pressure mode

The proportional pressure maintenance mode is recommended for pump operation in a radiator circuit in a two-pipe heating system. In this mode, the pump operating point will move up or down along one of the proportional pressure curves of the flow-pressure characteristic, depending on the actual flow rate in the system (see Fig. 13).

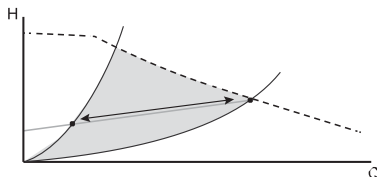

Fig. 13 Example of proportional pressure curve in proportional pressure maintenance mode

Constant pressure mode

The constant pressure mode is recommended for the operation of the pump in an underfloor heating circuit. The operating point of the pump will move along a constant pressure curve depending on the flow rate in the system.

As a result, the head (pressure) will remain constant regardless of the actual flow rate of the heat transfer medium (see .14).

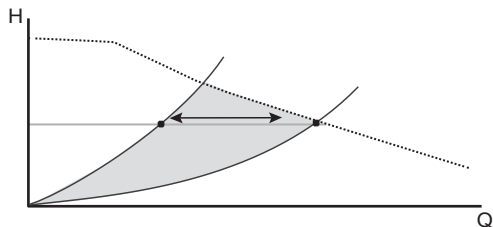

Fig. 14 Example of a constant pressure curve in constant pressure maintenance mode

Fixed speed modes

In fixed speed mode, the pump operates with a constant motor speed.

In this mode, the pump operates independently of the actual flow rate in the system (see 15). The pump has three fixed speeds to choose from. The choice of fixed speed depends on the hydraulic characteristics of the system and weather conditions.

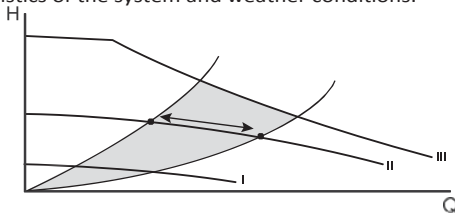

Fig. 15 Example of three fixed speed curves

Automatic operation mode AUTO

The pump analyzes the heating system and then, based on the results of the analysis, selects the best working proportional pressure line. The pump performance will vary along the selected straight line, always adapting to the actual load on the heating system. The pump selects a straight line from an unlimited number of straight lines in the AUTO range (shaded area in 16).

This control mode is recommended for two-pipe heating systems. After the pump is started in AUTO mode, it collects information on flow changes in the system for one week (168 hours) and, after this period, sets its operation on the new, most appropriate proportional control line from the AUTO zone.

If during operation of the pump in AUTO mode the power to the pump is interrupted or the owner selects a different operating mode for a period of if the AUTO mode is activated again, the pump will continue its operation on the previously set line. If more than 24 hours elapsed, when AUTO mode is selected, the pump starts its operation as a new one - from the PP II line, analyzes the system for a week, and then selects a new working line.

In case the AUTO mode does not provide the required flow rate, the owner of the pump can set the most suitable mode to ensure comfortable use of the heating system.

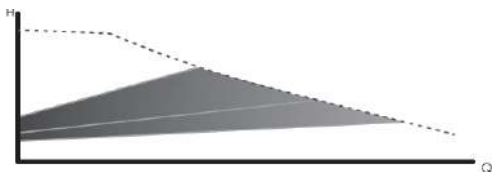

Fig. 16 Pump operation field in AUTO mode

12. Technical maintenance

If the pump is not running for a long period of time (disconnected from electricity), there is a high risk of the pump jamming. In order to avoid pump jamming during idle periods, the pump room should be cleaned to remove deposits and residual pumped liquid. Or switch the pump to proportional or constant pressure mode for the summer.

Guideline

Maintenance of the pump consists of keeping the product clean and regularly checking the integrity of the electrical cables, electrical blocks and connection of the inlet and outlet connections of the pump. Depending on the pumped medium (high water hardness, suspended solids, iron salts), cleaning of the pump part may be necessary.



Warning

Before starting any work on the pump, make sure that the power supply is switched off so that it cannot be switched on accidentally.



Warning

Provision must be made to protect personnel from injury and to prevent equipment damage from fluid escaping from the pump during maintenance work.

13. Withdrawal from operation

In order to take the Master SD pumps out of operation, the mains switch must be turned to position "Disabled."



Warning

All electrical lines upstream of the mains switch are permanently energized. Therefore, the mains switch must be locked out to prevent accidental or unauthorized activation of the equipment.

14. Protection against low temperatures

If the pump will not be operated during a period of sub-zero ambient temperature, the pump must be drained of the pumped liquid to avoid damage.

Attention

If there is a risk of damage to the pump during cold storage, the pump must be protected from low temperatures.

15. Technical data

| Performance data | | |
|--------------------------------------------------------|--------------------------------------------------------------------------------------------------------------------------------------|------------------|
| Sound pressure level | Does not exceed 45 dB(A). Measurement uncertainty characteristic (parameter K) is 3 dB. | |
| Relative humidity | 95% max, non-condensing environment environment | |
| System pressure | PN 10: Maximum 1 MPa (10 bar) | |
| Pump inlet pressure | Maximum 1 MPa (10 bar) | |
| Required minimum pressure at the pump inlet connection | Liquid temperature | Pressure |
| | ≤75 °C | 0,5 m (0.05 bar) |
| | 90 °C | 2,8 m (0.28 bar) |
| | 110 °C | 10 m (1 bar) |
| Ambient temperature | -30 °C ~+70 °C | |
| Pumped liquid temperature | -20 °C ~+110 °C | |
| Liquid | Maximum water/propylene glycol ratio = 50% Note: Glycol content reduces pump performance due to increased viscosity pumped liquid | |
| Viscosity | Maximum 10 mm ² /s (10 cSt) | |
| Maximum installation height in relation to sea level | 2000 m above sea level | |

| Electrical data | | |
|------------------------------------------------------|--------------------------------------------|------------------------------------|
| Rated supply voltage | 1x230 V \pm 10 %, 50 Hz, PE | |
| Heat resistance class of insulation materials | H | |
| Pump power consumption when the pump is switched off | < 1 W | |
| Inrush current | < 10A | |
| Pump on/off frequency | No special requirements | |
| General data | | |
| Engine protection | No additional protection required | |
| Protection class | IP 44 | |
| Temperature class | TF 110 | |
| Energy Efficiency Index EEI | Master SD XX-4/5/6/7/7.5 Master SD XX-8 | EEI \leq 0.20 EEI \leq 0.21 |

Pump operation at high and low supply voltages

Increased mains voltage: the pump switches off at 270 V and switches on automatically if it drops below 260 V; the I indicator flashes.

The pump can continue to operate at reduced voltages up to 165 VAC. However, the pump performance will be reduced.

Undervoltage: the pump switches off when the voltage drops below 165 V and automatically switches on when it returns above 170 V; indicator II flashes.

Prolonged operation of the pump at mains voltages other than the rated voltage may shorten its service life.

Attention

Dimensions

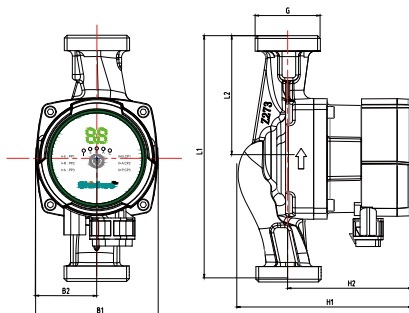

| Pump model | Size [mm] | | | | | | |
|--------------------|-----------|----|-----|----|-----|----|--------|
| | B1 | B2 | L1 | L2 | H1 | H2 | G |
| Master SD 20-X/130 | 90 | 45 | 130 | 65 | 135 | 90 | 1 1/2" |
| Master SD 25-X/130 | 90 | 45 | 130 | 65 | 135 | 90 | 1 1/2" |
| Master SD 25-X/180 | 90 | 45 | 180 | 90 | 135 | 90 | 2" |
| Master SD 32-X/180 | 90 | 45 | 180 | 90 | 135 | 90 | 2" |

Product range

| Pump model | Connection size | Port-to-port length mm | Rated power (W) | Rated current (A) | Voltage |
|------------------|-----------------|------------------------|-----------------|-------------------|----------|
| Master SD 25-4 | G 1 1/2" | 130/180 | 25 | 0.25 | 220-240V |
| Master SD 25-5 | | | 33 | 0.3 | 220-240V |
| Master SD 25-6 | | | 39 | 0.35 | 220-240V |
| Master SD 25-7 | | | 52 | 0.45 | 220-240V |
| Master SD 25-7.5 | | | 60 | 0.5 | 220-240V |
| Master SD 25-8 | | | 70 | 0.55 | 220-240V |
| Master SD 32-4 | G 2" | 130/180 | 25 | 0.25 | 220-240V |
| Master SD 32-5 | | | 33 | 0.3 | 220-240V |
| Master SD 32-6 | | | 39 | 0.35 | 220-240V |
| Master SD 32-7 | | | 52 | 0.45 | 220-240V |
| Master SD 32-7.5 | | | 60 | 0.5 | 220-240V |
| Master SD 32-8 | | | 70 | 0.55 | 220-240V |

16. Detecting and eliminating faults

If the pump has detected one or more alarms, the LEDs on the control panel flash continuously and an error code is displayed. The type of alarm can be determined from Table 1. If more than one alarm occurs at the same time, the LEDs will indicate the error with the highest priority.

Table 1: Troubleshooting and troubleshooting

| Error code | Error description and solution |
|-------------------------------------------------------------------------|----------------------------------------------------------------------------------------------------------------------------------------------------------------------------------------------------------------------------------------------------------------------------------|
| Indicators 1-5 flash simultaneously and display displays E1 | Overvoltage protection. Input supply voltage higher than 278 ± 10 V, the pump stops operation. When the voltage returns to 260 ± 10 V, the pump will resume operation. |
| Indicators 1-5 simultaneously doubly flashes and the display shows E2 | Undervoltage protection. Input voltage is below 160 ± 10 V. After 2 sec. the pump enters the low-pressure protection mode of voltage and stops working. When voltage will return to 170 ± 10 V, the pump will resume operation. |
| Indicators 1-5 simultaneously threefold flashes and display displays E3 | Overcurrent protection. If during pump operation hardware overcurrent is 3.25 A or more, it is switched on overcurrent protection. After that the pump will stop running immediately and will restart after 8 sec. If the fault is not eliminated, the display will be repeated. |

| Error code | Error description and solution |
|-------------------------------------------------------------------------|-----------------------------------------------------------------------------------------------------------------------------------------------------------------------------------------------------------------------------------------------------------------------------------------------------------------------------------------------------------------------------------------------------------------|
| Indicators 1-5 blink four times simultaneously and the display shows E4 | Phase loss protection. When the motor is out of phase, the pump will stop running immediately; the pump will restart after 8 sec. After the total number of protection actuations reaches 5, the pump will be stopped completely and will not restart, after which the power to the pump must be turned off and on again. |
| Indicators 1-5 blink five times simultaneously and the display shows E5 | Rotor lockout protection. The pump will stop its operation after 3 sec of rotor blockage and restart after 8 sec. If the fault is not corrected, after the accumulated number of protection activations reaches 5, the pump will be completely shut down and will not restart, to restart it must be powered off and on again. |
| Indicators 1-5 flash six times simultaneously and the display shows E6 | Underload protection. If the power is less than 10 W for 10 s after 10 s after the power supply is switched on, the underload protection is triggered, after which the pump restarts after 8 s. If the cumulative number of protection activations reaches 5, the pump will not restart. To restart, the pump must be powered off and then on again. Only fixed speed mode III has underload protection. |

| Error code | Error description and solution |
|--------------------------------------------------------------------------|---------------------------------------------------------------------------------------------------------------------------------------------------------------------------------------------------------------------------------------------------------------|
| Indicators 1-5 blink seven times simultaneously and the display shows E7 | Overheat protection. When pumping high temperature liquids, when the surface temperature of the IPM is above $125 \pm 10\%$ °C, the pump stops its operation. When the IPM surface temperature drops to $100 \pm 10\%$ °C, the pump will resume operation. |
| The I+A indicators flash simultaneously. | Increased ambient temperature - if the ambient temperature exceeds the maximum limit ($+70$ °C) by no more than 10 °C, the pump switches to the reduced power operation mode (50% of the maximum power); |
| The I-C indicators flash simultaneously. | If the ambient temperature exceeds the maximum limit by more than 10 °C, the pump stops; Once the ambient temperature has normalized, the pump automatically resumes operation. |



Warning

Before starting work, make sure that the power to the pump is switched off and take measures to prevent it from being switched on accidentally.

Actions in case of contamination of the flow part of pump

In case of contamination of the flowing part of the pump, it must be cleaned:

1. Before starting work, close the gate valves on each side of the pump, disconnect the power supply.
2. Remove the four set screws (4 or 5 mm) while holding the motor stator.
3. Carefully separate the stator housing from the pump casing.
4. Clean (rinse) the impeller.

- 
- Carefully insert the stator housing into the pump casing.
 - Insert the set screws and tighten them diagonally and with a constant torque (5 Nm).
 - Check that the impeller turns freely. If the impeller does not turn freely, repeat the disassembly/assembly process.

Critical failures can result:

- incorrect electrical connection;
- improper storage of equipment;
- damage or malfunction of the electrical/hydraulic/mechanical system;
- damage or malfunction of critical parts of the equipment;
- violation of rules and conditions of operation, maintenance, installation, control inspections.

To prevent erroneous actions, personnel must be thoroughly familiarized with this installation and operating manual.

In the event of an accident, failure or incident, the equipment must be stopped immediately and contact the service center.







17. Disposal of product



The main criterion for the limit state of a product is:

1. failure of one or more component parts that cannot be repaired or replaced;
2. increased repair and maintenance costs resulting in uneconomic operation.

This product, as well as assemblies and parts, must be assembled and disposed of in accordance with local environmental regulations.

19. Information on recycling packaging

| General information on labeling any type of packaging | | |
|-------------------------------------------------------------------------------------------------------------------------------------------------------------|--------------------------------------------------------------------------------------------|---------------------------------------------------------------------------------------------|
|  <p>The packaging is not intended to come into contact with foodstuffs</p> | | |
| Packing material | Name of packaging / packaging aids | Letter designation of the material from which the packaging/ packaging aids are made |
| Paper and cardboard (corrugated cardboard, paper, other cardboard) | Boxes/boxes, liners, gaskets, liners, liners, grates, retainers, packing material |  PAP |
| Wood and wood-based materials (wood, cork) | Boxes (board, plywood, fiberboard), pallets, laths, removable sides, strips, laths, clamps |  FOR |
| Plastic (low-density polyethylene) | Pouches, bags, foils, pouches, bubble wrap, retainers |  LDPE |

| Packing material | | Name of packaging / packaging aids | Letter designation of the material from which the packaging/ packaging aids are made |
|--------------------------------------------------------------------------------------------------------------------------------------------------------------------------------------------------------------------------------------------------------------------------------------------------------------------------------------------------------------------------------------------------------------------------------------------------------------------------------------------------------------------------------------------------------------------------------------------------------------------------------------------------------------------------|-----------------------------|---------------------------------------------------------------------------------------------------------|---------------------------------------------------------------------------------------------|
| Plastic | (high-density polyethylene) | Sealing gaskets (made of film materials), including air gaskets. bubble wrap, clamps, stuffing material |  HDPE |
| | (polystyrene) | Sealing gaskets made of foamed plastics |  PS |
| Combination packaging (paper and cardboard/plastic) | | Skin type packaging |  C/PAP |
| <p>Please pay attention to the marking of the packaging itself and/or the packaging aids (if applied by the packaging manufacturer). If necessary, in order to save resources and environmental performance, the manufacturer may reuse the packaging and/or packaging aids. The packaging, packaging aids and the materials from which they are made are subject to change at the manufacturer's discretion. Please contact the manufacturer of the finished product listed in section 18 for the latest information. Manufacturer. Service life of this Data Sheet, Installation Manual and operation. Please specify the article number when inquiring equipment.</p> | | | |

Shinhoo®

Anhui Shinhoo Canned Motor Pump Co., Ltd.
Address:NO.780, MINGCHUAN ROAD, HI-TECH DEVELOPMENT ZONE, HEFEI, ANHUI, CHINA
Tel:0086 551 6237 9807 Fax:0086 551 6237 9801
E-mail:info@shinhoodump.com

www.shinhoodump.com